

SBL.08.327.100  
Revision: 01

## KAWASAKI KLE 500

### Schutzbügel Montagehinweise

Alle vom Motorrad gelösten Schrauben sind gemäß Herstellerangaben wieder zu montieren, oder mit von SW-MOTECH gelieferten Schrauben zu ersetzen. Falls nicht anderweitig definiert, diese Schrauben nach Tabelle anziehen.

M6	9,6 Nm
M8	23 Nm
M10	46 Nm

Gegebenenfalls Schrauben mit flüssiger Schraubensicherung einkleben.

Prüfen Sie nach 50 km alle Verbindungen auf festen Sitz.

SW-MOTECH GmbH & Co. KG  
Ernteweg 8/10  
35282 Rauschenberg  
Germany

Tel. +49 (0) 64 25/8 16 8-00  
Fax +49 (0) 64 25/8 16 8-10

info@sw-motech.com  
www.sw-motech.com



### Crash Bar Mounting Instructions

SW-MOTECH products should be installed by a qualified, experienced motorcycle technician. If you are unsure of your ability to properly install a product, please have the product installed by your local motorcycle dealer. SW-MOTECH takes no responsibility for damages caused by improper installation.

All screws, bolts and nuts, including all replacement hardware provided by SW-MOTECH, should be tightened to the torque specified in the OEM maintenance manual for your motorcycle. If no torque specifications are provided in the OEM maintenance manual, the following torques may be used:

M6	9,6 Nm
M8	23 Nm
M10	46 Nm

All screws, bolts and nuts should be checked after driving the first 50 km to ensure that all are tightened to the proper torque.

Medium strength liquid thread-locker (i.e., "Loctite") should be used to secure all screws, bolts and nuts.

1 Schutzbügel  
Crash Bar

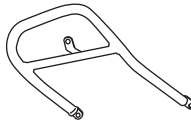

SBL.08.327.901/902  
Anzahl/ Pcs. 2 (L/R)

2 Innensechskant-  
schraube  
Hexagon Socket Screw

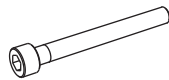

M10 x 300 DIN 912  
Anzahl/ Pcs. 1

3 Unterlegscheibe  
Washer



A 10,5 DIN 125  
Anzahl/ Pcs. 1

4 Mutter mit Bund,  
selbstsichernd  
Lock Nut with Flange



M10 DIN 6927  
Anzahl/ Pcs. 1

5 Anbautraverse  
Bracket

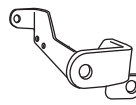

SBL.08.327.001  
Anzahl/ Pcs. 1

6 Sechskantschraube  
Hexagon Screw

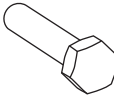

M10 x 1,25 x 35 DIN 961  
Anzahl/ Pcs. 1

7 Unterlegscheibe  
Washer



A 10,5 DIN 125  
Anzahl/ Pcs. 1

8 Bügelschraube  
Bowscrew

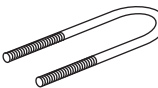

BUS.00.08.043.068.01  
Anzahl/ Pcs. 1

9 Mutter mit Bund,  
selbstsichernd  
Lock Nut with Flange

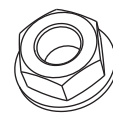

M8 DIN 6927/b  
Anzahl/ Pcs. 2

10 Innensechskant-  
schraube  
Hexagon Socket Screw

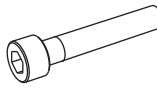

M8 x 25 DIN 912  
Anzahl/ Pcs. 2

11 Unterlegscheibe  
Washer



A 8,4 DIN 125  
Anzahl/ Pcs. 2

12 Mutter mit Bund,  
selbstsichernd  
Lock Nut with Flange



M8 DIN 6927/b  
Anzahl/ Pcs. 2

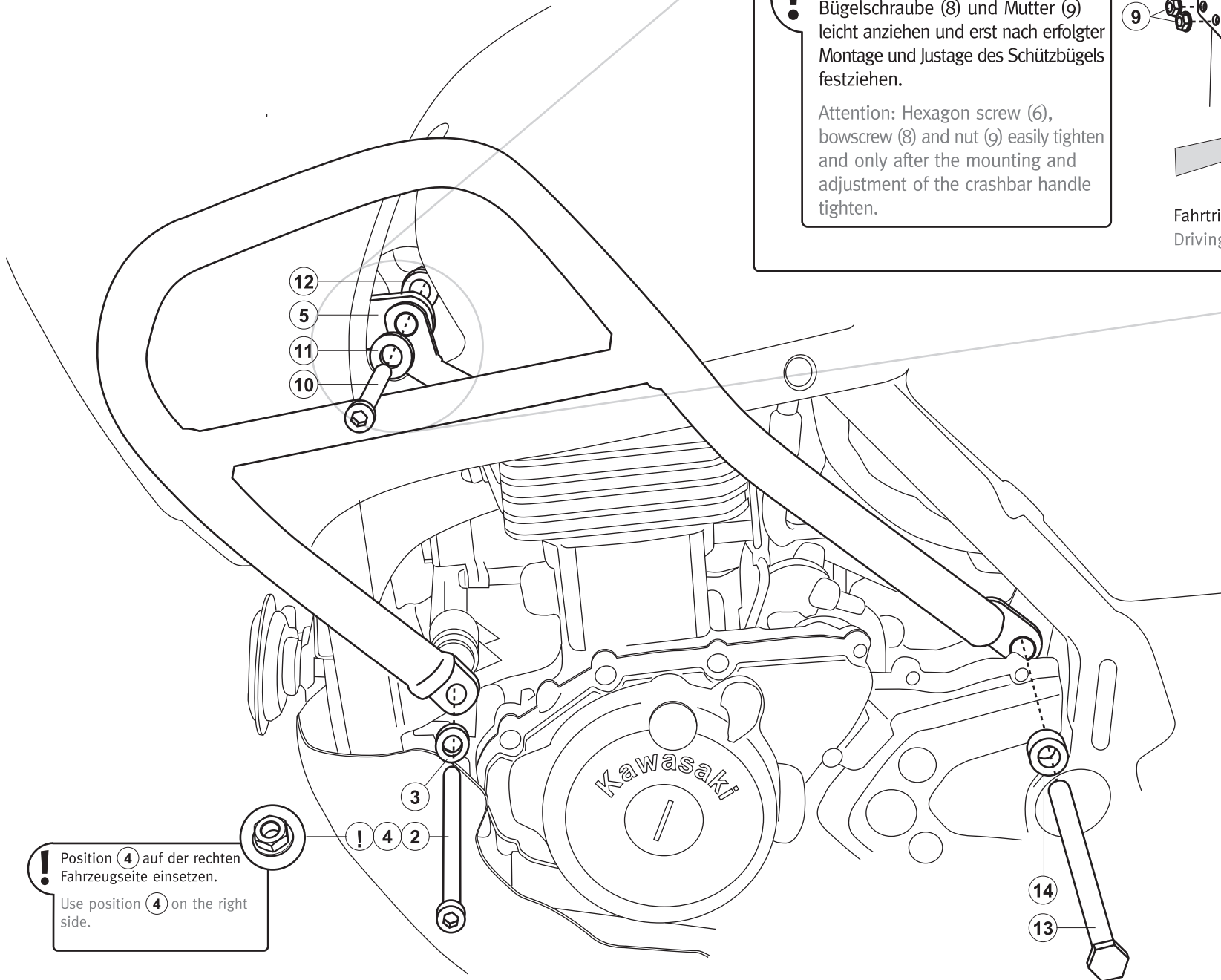

**!** Achtung: Sechskantschraube (6),  
Bügelschraube (8) und Mutter (9)  
leicht anziehen und erst nach erfolgter  
Montage und Justage des Schützbügels  
festziehen.

Attention: Hexagon screw (6),  
bowscrew (8) and nut (9) easily tighten  
and only after the mounting and  
adjustment of the crashbar handle  
tighten.

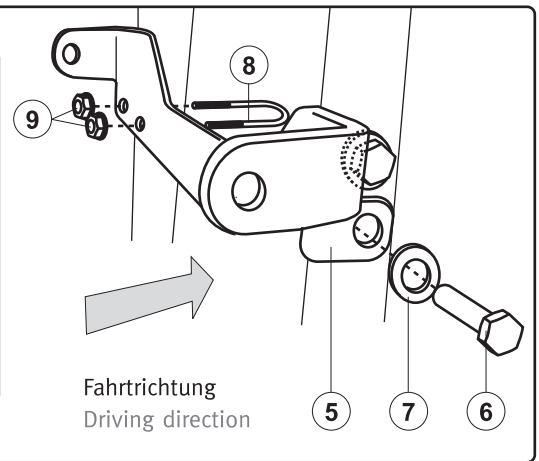

**!** Position (4) auf der rechten  
Fahrzeugseite einsetzen.  
Use position (4) on the right  
side.

13 Sechskantschraube  
Hexagon Screw

M10 x 180	DIN 931
Anzahl/ Pcs.	1

14 Distanzbuchse  
Spacer

Da:20 Di:10,5 h:6	
Anzahl/ Pcs.	1

**←**  
Fahrtrichtung  
Driving direction